

# TRILUX Medical in Normal Care

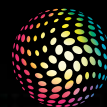

**TRILUX**  
ENGINEERING HEALTH.



TRILUX Medical GmbH & Co. KG

## Healing. Get well soon.

Patient rooms in normal care environments are all about achieving a fine balance. For nurses these are their workplace, demanding high levels of precision, rapid responses in emergencies and multi-tasking capabilities. For patients they represent a temporary home, providing a sense of comfort and intimacy. Hospital managers see costs and for planners they are the ultimate challenge. TRILUX Medical provides all-round satisfaction, with lighting systems and supply solutions that achieve a highly intelligent blend of technology, design and economics. Well designed. Well built.

Your  
TRILUX Medical Team

**LIGHT CHANNEL**  
Standard-compliant, glare-free orientation, reading and examination light  
// Dimmable // LED technology

**WALL PANEL**  
Interior design accents // Luminaire mounting and installation of medical supply units within a decorative system

**LATERAL SUPPLY**  
A cosy atmosphere thanks to laterally positioned supply elements e.g. switches, power sockets, communication systems and gas outlets

**NIGHT LIGHT**  
Glare-free, direct distribution LED orientation light // Orientation and safety for patients and nurses during the night



TRILUX Medical  
**Lighting solutions.**  
**Everything.**  
**Except normal.**

There's nothing „normal“ about Normal Care. Each hospital, station or room has its special needs and problems – also in terms of light. For this reason, TRILUX Medical's lighting solutions are anything but normal, which means not only better and more innovative products, but individual lighting solutions tailored to specific situations. Light from TRILUX Medical creates:

Working environments in which care personnel do not tire, are able to respond more quickly, make fewer mistakes and, in this way, also ensure a high standard of care // An atmosphere of well-being in which patients find their bearings at all times and can read and watch television without exerting themselves, all the time accompanied by a feeling of security // Premium quality, high luminous intensity with low energy consumption, guaranteed durability and disruption-free operation.

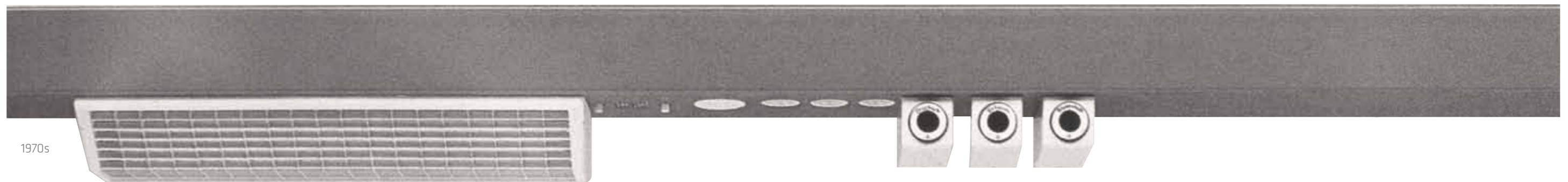

1970s



Today

TRILUX Medical  
Our invention:  
**The supply unit.**

The demands on technology and equipment in hospitals expanded rapidly in the 1960s. What hospitals really needed were systems that brought together medical gases, high and low voltage current and lighting within a single unit. As a partner for hospitals, TRILUX Medical accepted the challenge and developed highly functional supply systems for patient rooms in clinics and hospitals. Revolutionary!

A world first: TRILUX presented this innovation in 1965 at a specialist fair for hospital equipment in Dortmund, Germany and in the following years TRILUX Medical continued to develop the system and adapted it to increasing demands in terms of new technologies, cosy atmospheres, stringent hygiene and maintenance-friendly technology. What remains is the highest standard globally, as provided by TRILUX Medical supply units in patient rooms and care environments. Mature, ergonomic and intelligent.





## TRILUX Medical Kubion. Elegantly concealed values.

The modular wall supply system complies with the high requirements for modern patient supply units. The Kubion is equipped with a host of functions, is easy to clean, has a wide diversity of applications and simply makes the working day easier for care personnel. The linear design of the basis module can be individually and stylishly adapted with diverse colours and wooden decor and can also be expanded with various decor modules. This means an attractive and custom-designed wall supply system can be created very quickly, making everyday care significantly easier thanks to many intelligent details.

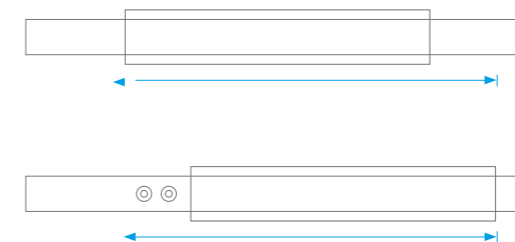

TRILUX Medical Kubion

# Highlights.

### CENTRAL CONNECTION POINT

Left or right at the end of the basis profile // For all incoming electrical and communication technology lines // Connection of copper tubes for medical gases (standard and premium versions)

### AMBIENT LIGHTING

LED ambient lighting on the upper and lower sides of the decor module, providing a pleasant atmosphere in patient rooms

### DECORATIVE OPTIONS

Four standard options are available for the decor module and basis profile // Expanded decor selection with the Wodego colour match range // Interior design decor can be used

### LED TECHNOLOGY

High performance LED technology // Longer service life // No re-lamping required // Lower energy consumption

### INSTALLATION-FRIENDLY

Simple mounting with optional accessories // Mounting frame for fixing on-site electrical and gas supply lines via front and rear infeed // Mounting accessories for plasterboard walls (ZH 4450)



TRILUX Medical Kubion

# Features.

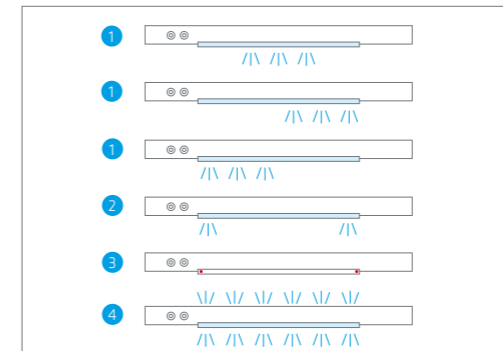

### PREMIUM LED READING LIGHT MODULE

- 1 Reading light for variable positioning of the bed and bedside table // Electronically adjustable, adaptable to the bed position
- 2 Integrated orientation lighting
- 3 Optical display for assignment of nurse call
- 4 Integrated push button to activate examination light

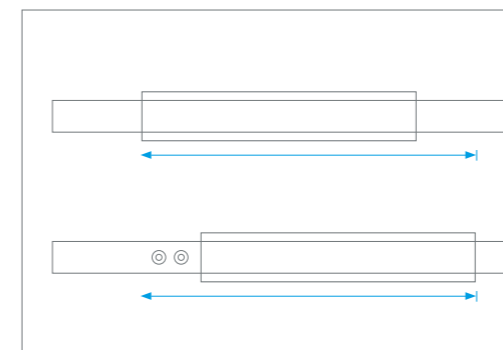

### SLIDABLE DECOR MODULE

Cosy atmosphere by covering a maximum of two gas outlets with the slidable decor module

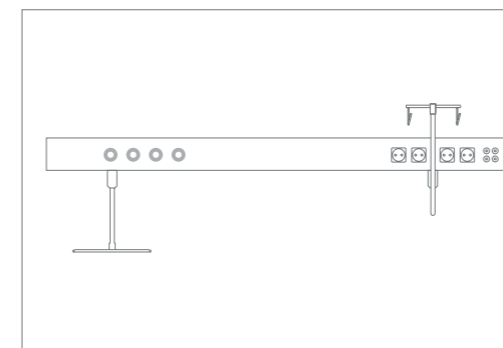

### CAN BE UPGRADED TO INTERMEDIATE CARE

Installation of socket outlets and communication components into the front profile // Optional accessories e.g. infusion bottle holder and medical rail

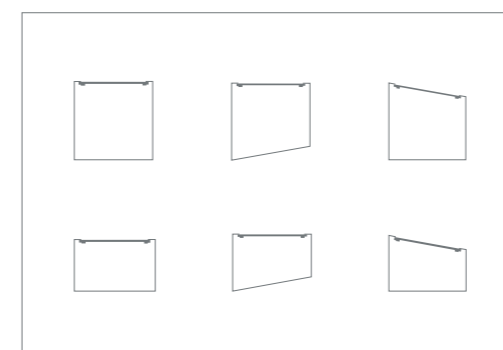

### MODULAR KIT

Two profile sizes (square, rectangular) // Profile cross-section with 10° angle below for improved accessibility of installation components // Profile cross-section with 10° angle above, preventing the placing of objects there

TRILUX Medical Kubion

## Product versions.

Description	View	Base conduit						Decor module (with wooden decor)			Front profile		Feeding		Plaster frame		Front-side installation of electrical components					
		Oblique	Frontal							Fixed	Slidable	Ambient light	Anodised or paint-finish	Wooden decor	Electrical	Gas		Electrical	Gas			
<b>BS 1</b> Luminaire wall luminaire, optionally with simple electrical components												Anodised only		Central	-	-	-					
<b>BS 2</b> with on-site extra low voltage wiring and gas connection directly behind the gas outlet														Left or right, front or rear	Directly from wall	Rear only	-					
<b>SD 1</b> without decor module														Left or right, front or rear								
<b>SD 2</b> with decor module																						
<b>SD 3</b> with decor module and ambient lighting with translucent luminous strip on top and bottom																						
<b>PM 1</b> with slidable decor module																						
<b>PM 2</b> slidable decor module and ambient light with translucent luminous strip on top and bottom																						
<b>PM 3</b> LED reading light module, electronically movable																						

BS: Basic, SD: Standard, PM: Premium

TRILUX Medical Kubion

## Accessories.



**ZH 5000 KUBION HOOK FOR T-SLOT**  
Hook which can be fixed to underside T-slot //  
Pack of 10 // Weight 0.2 kg // Load capacity 2.0 kg



**ZH 5020 KUBION INFUSION BOTTLE HOLDER**  
Infusion bottle holder for accommodating two gravity infusions // Weight 1.0 kg // Load capacity 5.0 kg



**ZH 5010 KUBION SHELF**  
Shelf for telephone or other objects // Metallic grey paint-finish, RAL 9006 // Size 380 x 240 mm // Weight 1.8 kg // Load capacity 5.0 kg



**ZH 5030 KUBION MEDICAL RAIL**  
Medical rail for accommodating small devices // Brushed stainless steel, 25 x 10 mm // Length 380 mm // Weight 1.0 kg // Load capacity 5.0 kg

TRILUX Medical BS 400.  
A cosy design  
**with functionality.**

A cosy, vertical-design normal care system with discreetly concealed supply technology. The BS 400 creates a comfortable atmosphere, at the same time providing functions that help simplify everyday life for nurses and patients. The system fulfils requirements for both normal and intermediate care. The surfaces can be designed according to taste using four standard wooden decor and further decor options from the Wodego colour match range.



TRILUX Medical BS 400

**Highlights.**

**CENTRAL CONNECTION POINT**

Connection on rear or from above via the intermediate ceiling //  
For all incoming electrical and communication technology lines //  
Connection of copper tubes for medical gases

**INSTALLATION-FRIENDLY**

Simple mounting with removable front plate //  
Large connection area

**SIMPLE COMPONENT ACCESS**

Opening the front panel enables easy access to cables and  
installation components installed in the side profiles //  
Simple maintenance

**DIVERSE DESIGN OPTIONS FOR BED PANELS AND LIGHTING**

Multiple combination options due to diversity of profile sizes for  
single and twin rooms // Central panel between beds or panel  
with side profiles for corner installation // Can be combined with  
Kubion wall luminaire



TRILUX Medical BS 400

## Features.

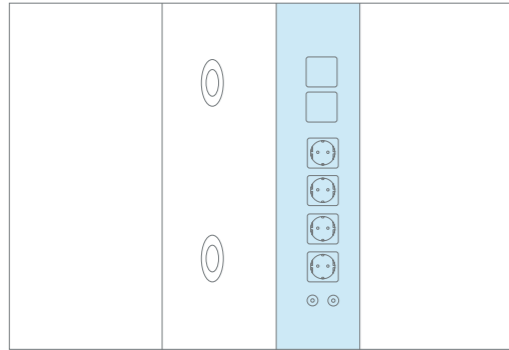

### FLUSH INSTALLATION

TRILUX Medical installation components are frameless and flush-mounted into the profile; optimal for cleaning and disinfection // Anodised aluminium surfaces

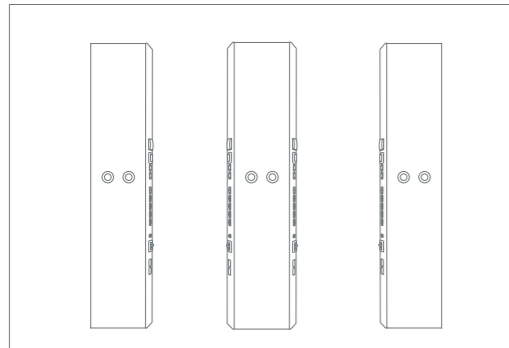

### VARIANTS

Bed panel as corner panel with 90° side profile // Central panel between beds

From left to right: BS 400 L // BS 400 M // BS 400 R

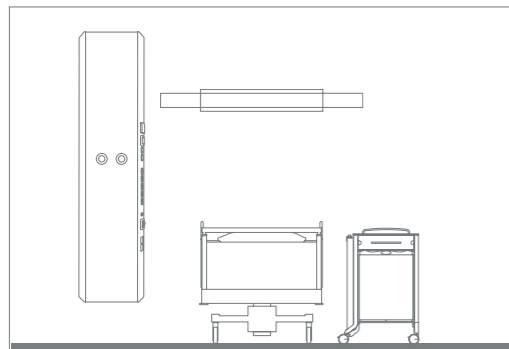

### PROJECT SOLUTION: BS 400 WITH KUBION WALL LUMINAIRE

The BS 400 can be combined with a Kubion wall luminaire to create perfect supply systems for patient rooms

TRILUX Medical BS 400

## Equipment.

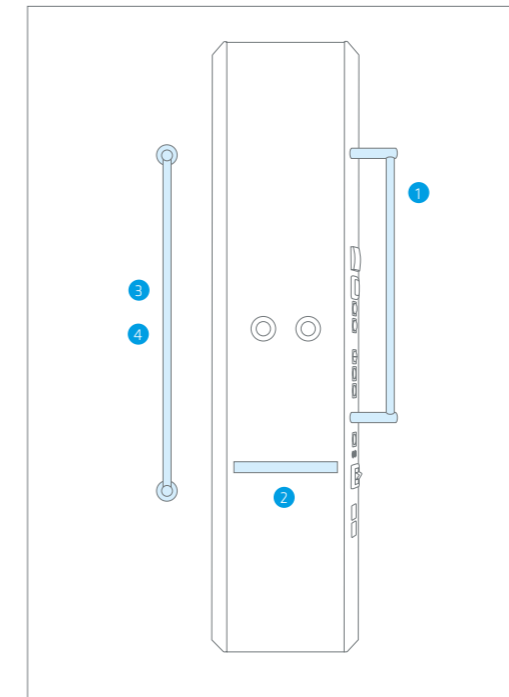

### CAN BE UPGRADED TO INTERMEDIATE CARE

- 1 ZH 4660 gear tray //  $\varnothing$  25 mm // Brushed stainless steel // Length 800 mm // With 2 brackets, can be laterally fixed // Weight 1.7 kg // Load capacity 25 kg
- 2 ZH 4610 medical rail // Stainless steel 25 x 10 mm // Length 350 mm // For front mounting // Weight 4.5 kg // Load capacity 10 kg
- 3 ZH 4620 (solid wall) and ZH 4630 (plasterboard wall) gear tray  $\varnothing$  38 mm // Brushed stainless steel // Length 1,500 mm // For wall mounting // Weight 6.1 kg // Load capacity 100 kg
- 4 ZH 4640 (solid wall) and ZH 4650 (plasterboard wall) gear tray  $\varnothing$  25 mm // Brushed stainless steel // Length 1,500 mm // For wall mounting // Weight 5.7 kg // Load capacity 60 kg

Further accessories for gear trays and medical rails in the TRILUX Medical VS 100 accessories flyer at [www.trilux-medical.com/en/accessoriesflyer](http://www.trilux-medical.com/en/accessoriesflyer)

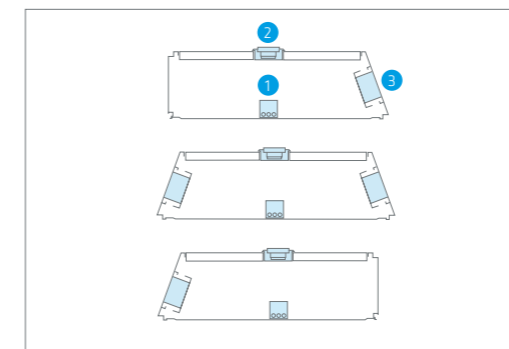

### CONSTRUCTION BS 400

- 1 Separate piping for medical gases
- 2 Medical gas outlets
- 3 Socket outlets for power supply and installed parts for communication technology

## TRILUX Medical VS 300. Technology with **ambitious design.**



The VS 300 is flush-mounted and perfectly complements any interior design. Installation is either horizontal or vertical, e.g. between two beds. The VS 300 complies with the hygiene requirements in normal care. For normal care rooms that combine a cosy atmosphere for patients with highly practical care functionality.

TRILUX Medical VS 300

## Highlights.

### LOW-MAINTENANCE

No integrated moving parts // All TRILUX Medical installation components e.g. power sockets, switches etc. are maintenance-free // Maintenance-free solder connections with gas outlets in the VS 300.

### HYGIENE

TRILUX Medical installation components are frameless and flush-mounted into the profile, optimal for cleaning and disinfection.

### DESIGN

Functional, timeless design // Suitable for any interior design.

### UPGRADING

The use of modular front panels means that installation components can be replaced or supplemented at any time.

### INDIVIDUAL ARCHITECTURAL SOLUTION

VS 300 installed in a wall panel // Superimposed light channel for indirect, reading and orientation light.



Example of an individual architectural solution

TRILUX Medical VS 300

## Features and equipment.

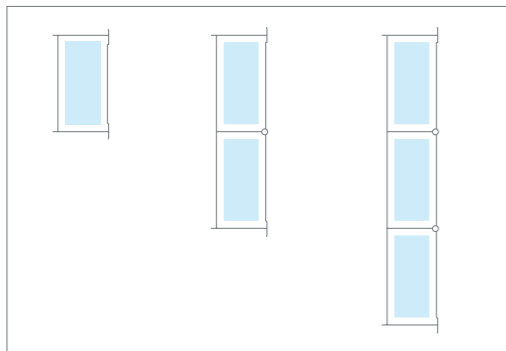

### EXPANSION LEVELS

Installation housing and profile frame flush-mounted into the wall // Single, double or triple versions // Equipped with electrical, extra low voltage and gas components in separate supply channels

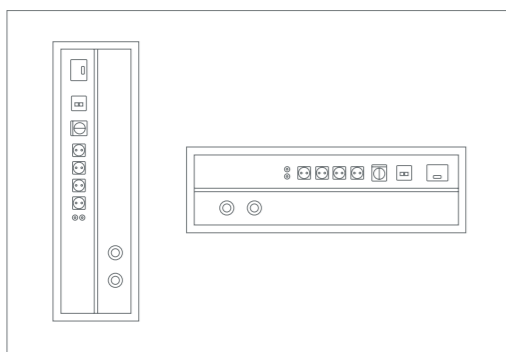

### HORIZONTAL OR VERTICAL CONFIGURATION

Highly compact patient care // Individual room design with minimum spatial requirements // Selectable positioning of the installation panel // All components easily accessible

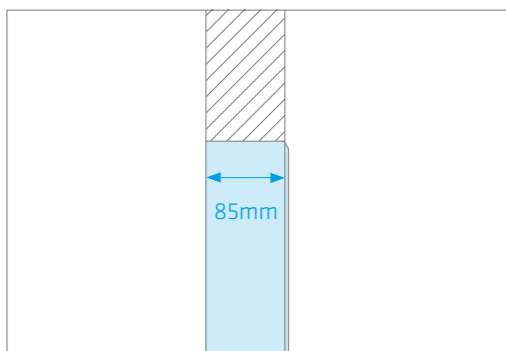

### LOW WALL RECESSED DEPTH

The panel can be installed either horizontally or vertically with a recessed depth of just 85 mm // The compact construction also enables installation between two beds

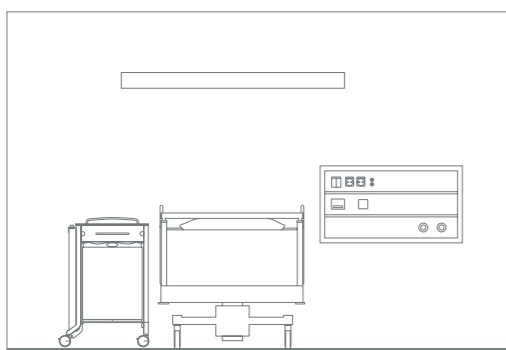

### PROJECT SOLUTION: VS 300 WITH KUBION WALL LUMINAIRE

The VS 300 can be combined with a Kubion wall luminaire to create perfect supply systems for patient rooms

## Technical data.

### Kubion decors (front profile) // BS 400

WODEGO  
R5447 MP  
Maple After Eight



WODEGO  
R5201 VV  
Maple Tessin Natural



WODEGO  
R5681 VV  
Cherry Havana



WODEGO  
R5674 VV  
Light Malaga Cherry



### Kubion colours (front profile) // VS 300

Standard

RAL 9002  
Grey white

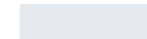

RAL 9006  
White Aluminium



RAL 9016  
Traffic white

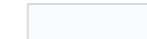

Anodised  
aluminium\*



Cosy

RAL 3031  
Orient red



RAL 3017  
Rosé



RAL 8025  
Pale brown



RAL 4007  
Purple violet



Elegant

RAL 9001  
Cream white



RAL 1015  
Light ivory



RAL 1019  
Grey beige



RAL 1017  
Saffron yellow



Modern

RAL 5012  
Light blue



RAL 4005  
Blue violet



RAL 4009  
Pastel violet



RAL 6019  
White green



Further colours and decor styles available upon request.  
\*not for the VS 300

### KUBION

#### Technical data

Basis profile	150 x 150 mm	150 x 95 mm
Decor module (L x W x H)	1.200 x 20 x 210 mm	

#### Lighting

	Fluorescent lamps	LED (supply includes LEDs)
Indirect lighting	2 x 54 W/49 W T16	1 x 68 W LED
Reading light	1 x 36 W TC-L	7 x 1,5 W LED
Movable reading light		1 x 15 W LED
Orientation light		1 x 1,5 W LED

#### Accessories

Electrical plaster frame	TRILUX Medical plaster frame for electrical infeed
Gas plaster frame	TRILUX Medical plaster frame for gas infeed
Solid wall mounting accessory	Recommended: Fischer dowels UV 8 x 50 with screw 6 x 50
Plasterboard wall mounting accessory	ZH 4450 (standard and premium versions)

**BS 400**

Basis profile		
Basis profile BS 400 (W x D)	520/420 x 150 mm	
Profile length (H)	2.100 mm	
Lighting with Kubion	Fluorescent lamps	LED (supply includes LEDs)
Indirect lighting	2 x 54 W/T16	1 x 68 W LED
Reading light	1 x 36 W TC-L	7 x 1,5 W LED
Orientation lighting in the BS 400		
Direct orientation lighting	1 x 1,5 W LED	
Accessories		
Solid wall mounting accessory	Recommended: Fischer dowels UV 8 x 50 with screw 6 x 50	
Plasterboard wall mounting accessory	ZH 4430	

**VS 300**

Basis profile	300	600
VS 301 (L x W x H)	175 x 352 x 85 mm	175 x 652 x 85 mm
VS 302 (L x W x H)	288 x 352 x 85 mm	288 x 652 x 85 mm
VS 303 (L x W x H)	403 x 352 x 85 mm	403 x 652 x 85 mm
Lighting with Kubion	Fluorescent lamps	LED (supply includes LEDs)
Indirect lighting	2 x 54 W/T16	1 x 68 W LED
Reading light	1 x 36 W TC-L	7 x 1,5 W LED
Orientation lighting in the VS 300		
Direct orientation lighting	1 x 1,5 W LED	
Accessories		
Solid wall plaster frame	VS 300 EPR TRILUX Medical plaster frame	

**GENERAL (APPLICABLE FOR SUPPLY UNITS ONLY)**

Central connection area		
Electrical	110 - 240 V	
	12 - 60 V	
Medical gases	3 tube circuits per system	Kubion, BS 400
	6 tube circuits per system	VS 300
Electrical components		
Standards	DIN, BS, NF	further standards upon request
Electric circuit	6 per system	
Power sockets	6 per bed	white, green
Potential equalisation pins	4 per bed	
Switches, push-buttons	2 per bed	
Communication components		
Nurse call	1 per bed	max. dimensions of components 300 x 73 x 45 mm (L x W x H)
Telephone socket	1 per bed	RJ 11, 12, 45, cat5, cat5e, cat6
Data socket	1 per bed	RJ 45, cat5, cat5e, cat6
Opening with cover	1 per bed	
Medical gases		
Standards	DIN, BS, NF, AGA	further standards upon request
Gas outlets	3 per bed	oxygen, compressed air, vacuum



**TRILUX Medical GmbH & Co. KG**

Huettenstrasse 21

D-59759 Arnsberg

Tel: +49 (0) 29 32 . 301 - 100

Fax: +49 (0) 29 32 . 301 - 121

info-medical@trilux.de

www.trilux-medical.com

All technical data and the weight and dimensional specifications are carefully compiled, but no liability is accepted for errors. We reserve the right to make changes that reflect improvements.

Product in some cases are shown with accessories that must be ordered separately. Illustrations may show products with optional equipment.